







28 565 977



- rain shower Ø 200 mm
- PURE RAIN, max. flow rate 6.8 l/min (at 3 bar)
- distance between ceiling and lower edge of the shower 185mm
- rosette Ø 55 mm
- 1/2" connection
- with anti-scale system
- This product reduces water consumption by % (compared to requirements of EPAct '92)
- This product can help a building meet the requirements of Green Building Rating Systems, e.g. LEED®, BREEAM®, DGNB

	Chrome	28 565 977-00 0010
	Brushed Platinum	28 565 977-06 0010
	Platinum	28 565 977-08 0010
	Durabross (23kt Gold)	28 565 977-09 0010
	Brushed Durabross (23kt Gold)	28 565 977-28 0010
	Brushed Dark Platinum	28 565 977-99 0010

Required miscellaneous



- Concealed wall elbow -** 35 085 970-90
- max. recess depth 163 mm 0010
 - min. recess depth 90 mm



MADISON Rain shower with ceiling fixing 200 mm - Chrome

MADISON

28 565 977

mm [inches]

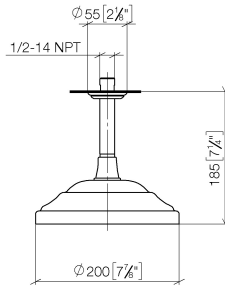

Flow rate chart



Codes & Standards

ASME
A112.18.1/CSA
B125.1

California Energy
Commission
(CEC)

Water Sense





MADISON Rain shower with ceiling fixing 200 mm - Chrome

MADISON

28 565 977

Certificates

IAPMO_11777.

IAPMO_4976 (2).

28 565 977

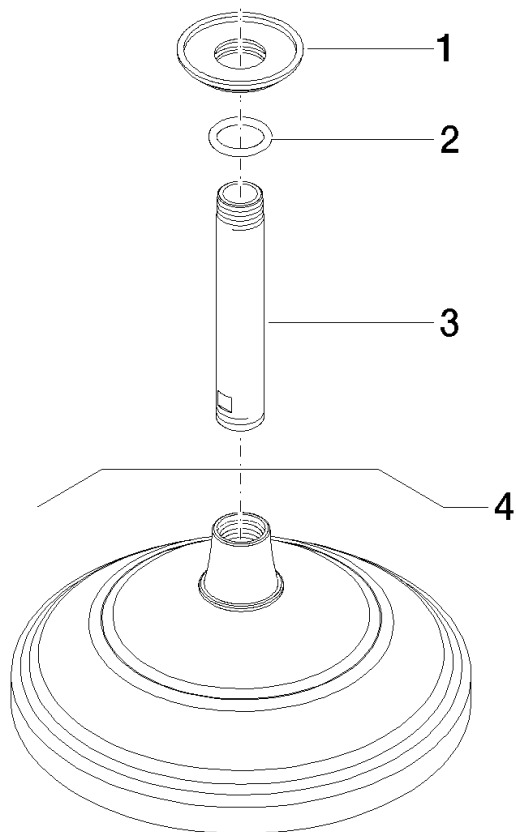

Spare parts list

No.	Item Number	Name	Quantity used	Delivery time
1	09 27 35 003-00	rosette	1	10
2	90 14 10 026 00 90	seal	1	2
3	09 11 03 018-00	connection	1	10
4	28 535 977-00 0010	shower	1	60